

➤ Instructions

Thule Evo Raised Rail 7104

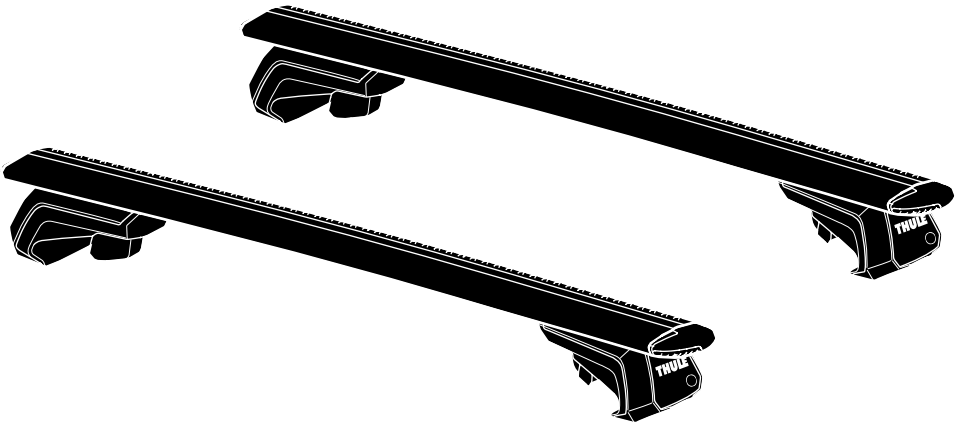

EN Roof mounted load carrier
DE Lastenträger zur Dachmontage
FR Barre de toit
NL Dakdrager
IT Barra portatutto da installare sul tetto
ES Portaequipajes de techo
PT Barra para montagem no tejadilho
SV Takmonterad lasthållare
DK Tagmonteret lastholder
NO Takmontert lasteholder
FI Katolle asennettava teline
ET Katusele paigaldatav katuseraam
LV Uz jumta uzstādāms kravas turētājs
LT Ant stogo tvirtinamas krovinių laikiklis
PL Uchwyt na bagażnik bazowy montowany na dachu
RU Багажник на крышу
UK Багажник для даху
BG Багажник, монтиран върху покрива
CS Nosič pro montáž na střechu
SK Strešný nosič
SL Nosilec za strešni prtljajnik

HR/BIH Krovni nosač tereta
RO Suport încărcătură montat pe acoperiș
HU Tetőre szerelhető csomagszállító
EL Σχάρα οροφής για μεταφορά φορτίου
TR Araç üstüne bağlanan yük taşıyıcı

HE מנשא מטען על הגג
AR حامل نقل مثبت على السقف

ZH 顶置行李架
JA ルーフマウント型ロードキャリア
KO 루프 장착 화물 캐리어
TH โครงยึดของบรรทุกแบบติดตั้งบนหลังคา

CITY CRASH
 Complies with ISO norm

ISO 11154-E

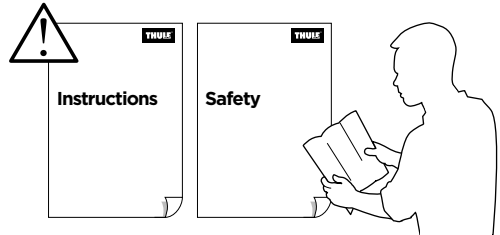

>Mounting Tutorial

Thule Evo Raised Rail

thule.com

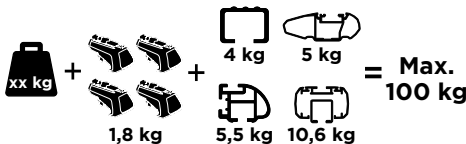
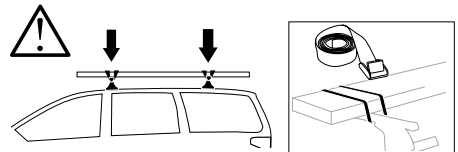
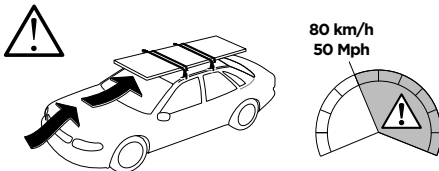

2
FOOT PACK

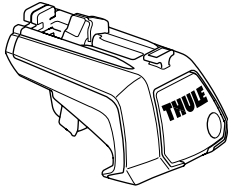

x4



x4



x2

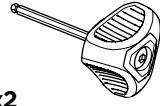

4 Nm

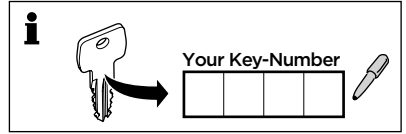

3
BAR

3



THULE
WingBar Evo

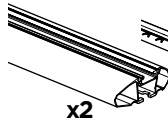

x2

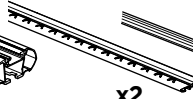

x2



x2



x2



x2



THULE
WingBar

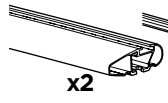

x2

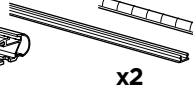

x2



x2

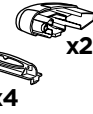

x2



x2



THULE
SlideBar

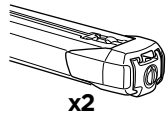

x2

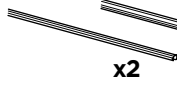

x2



x2

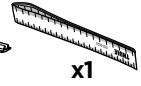

x1



x2



x1



THULE
ProBar

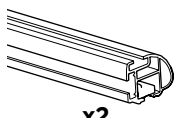

x2

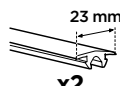

x2

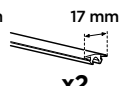

x2



x1



x2



x2



THULE
SquareBar

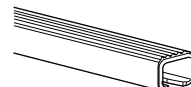

x2



x4



1

A

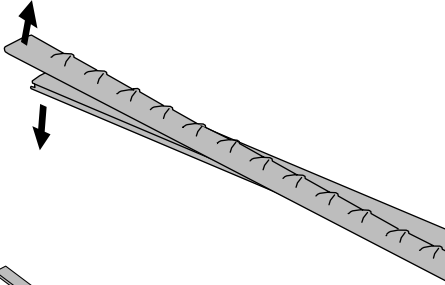

B

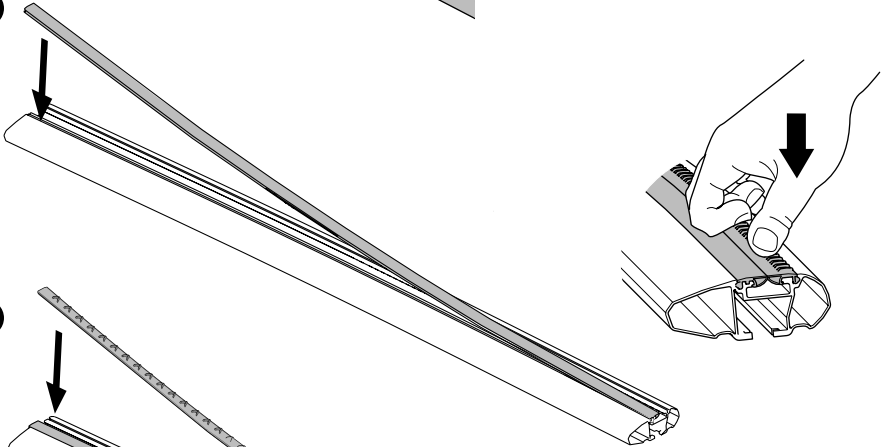

C

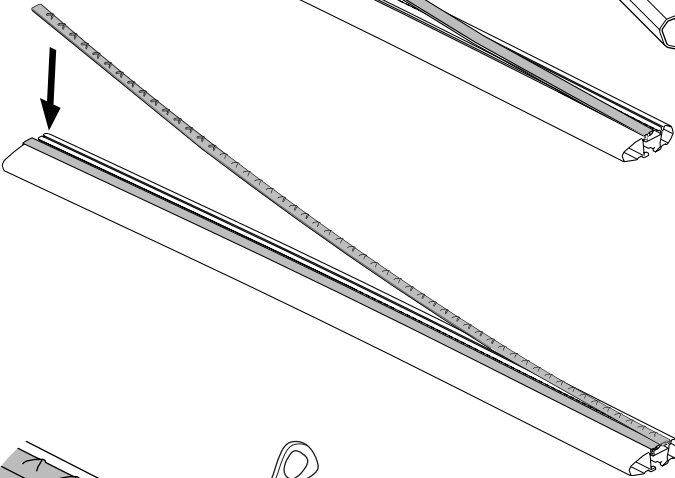

D

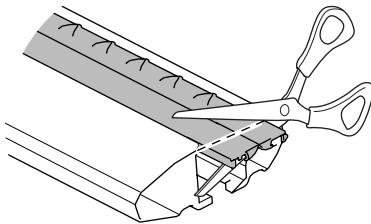

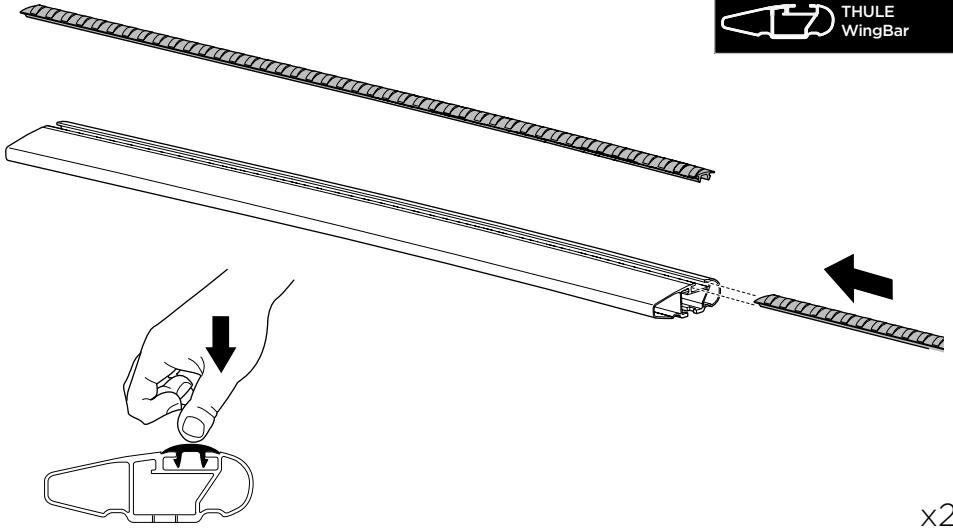

x2

2



A



B



C

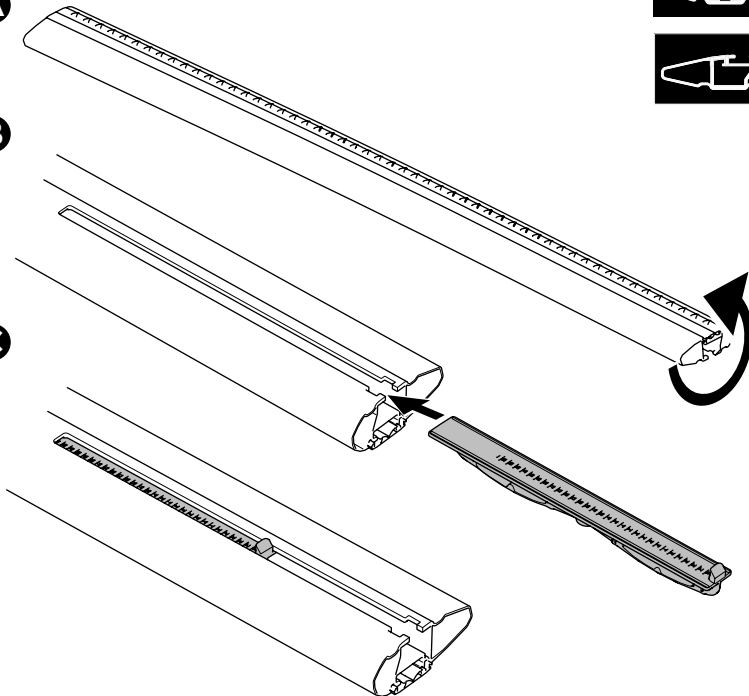

x4

3

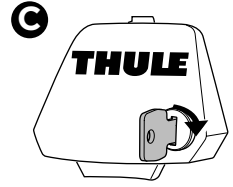
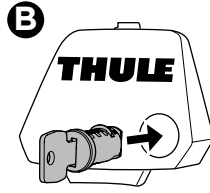
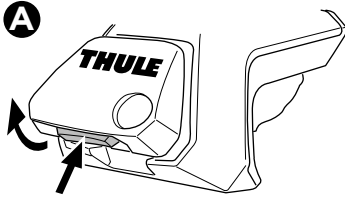

x4

4

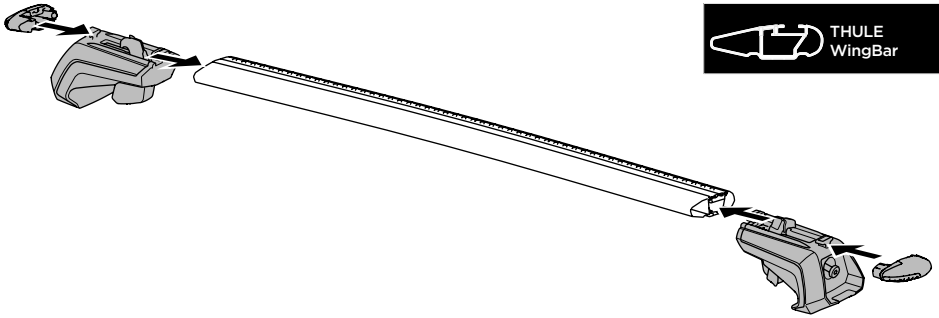

x2

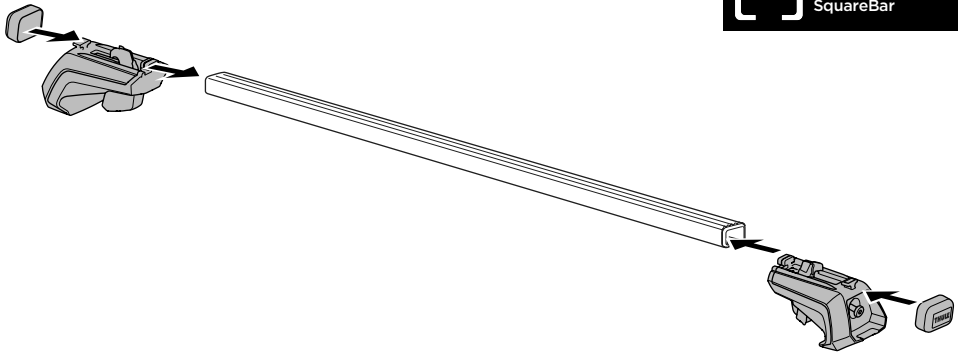

x2

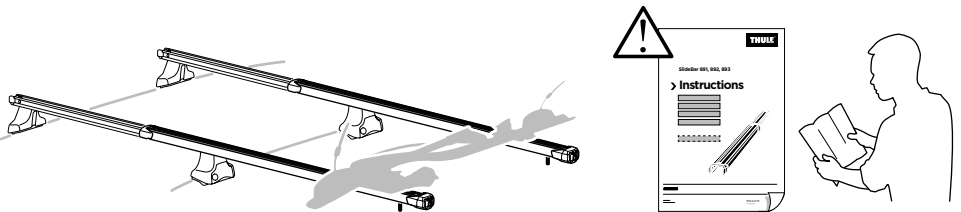
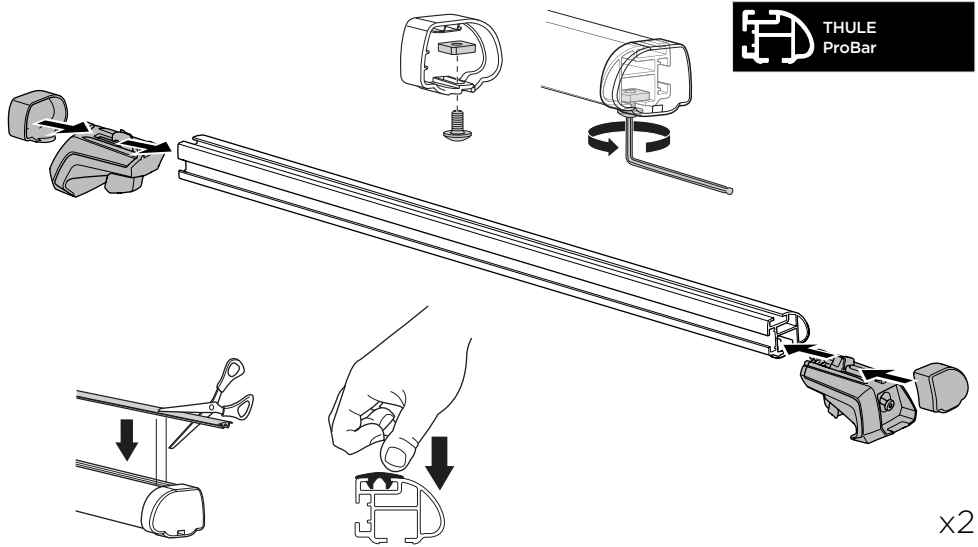

5

A

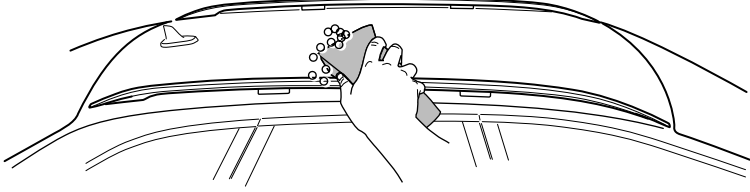

B

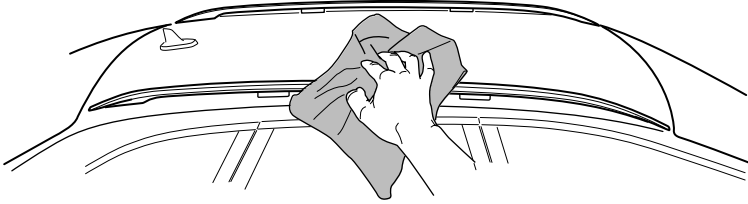

6

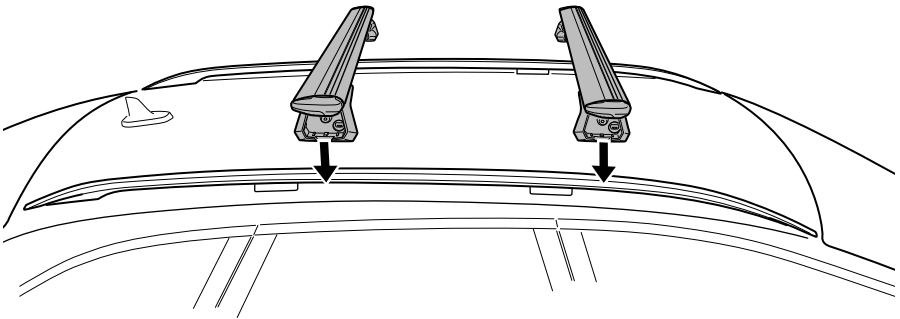
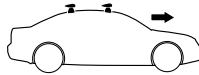

7

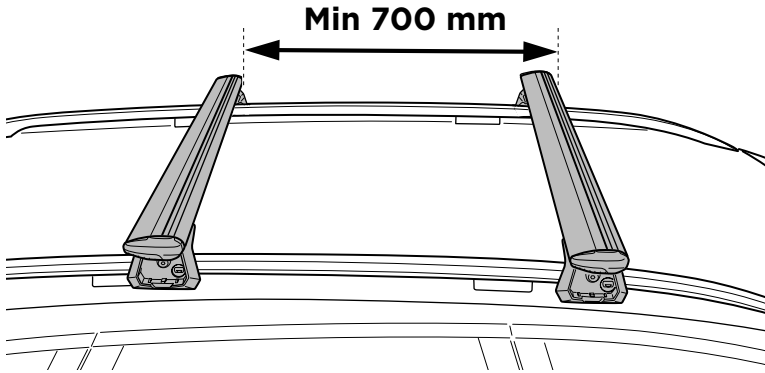

8

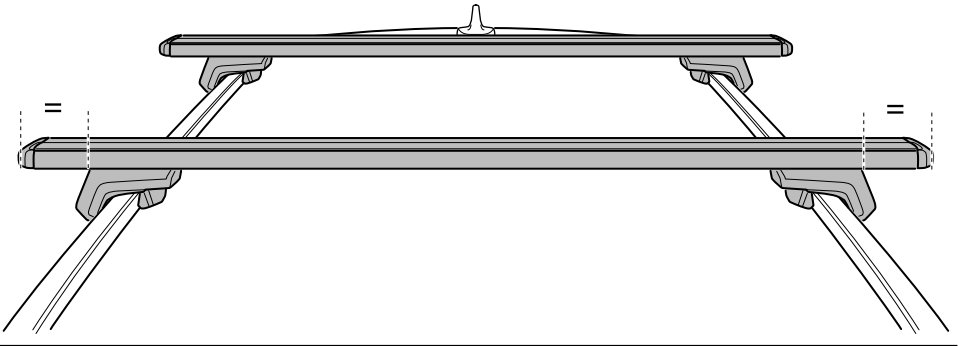

9

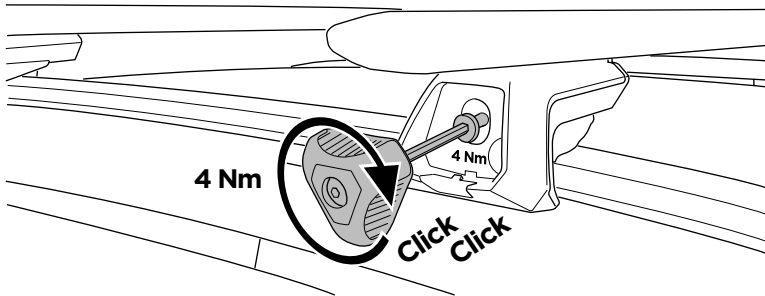

x4

10

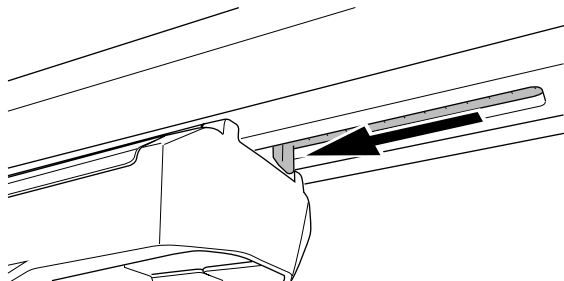

x4

11

A

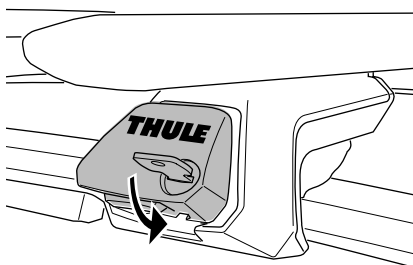

B

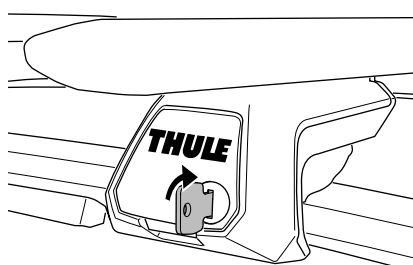

x4

12

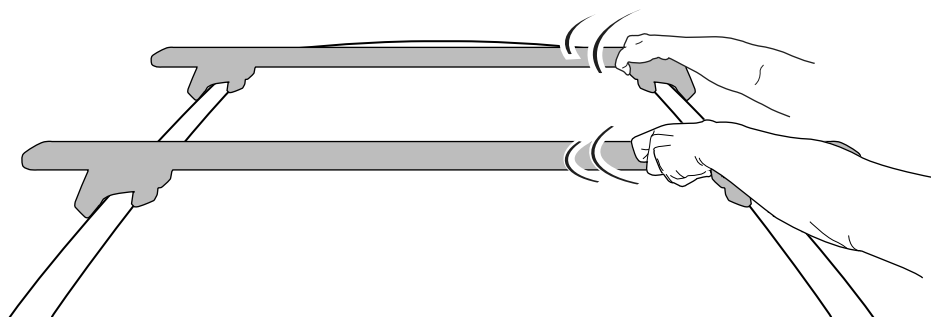

13

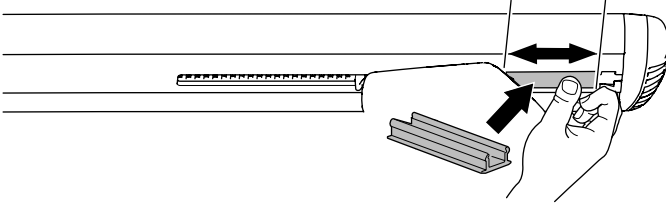
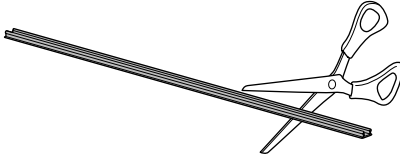

x4

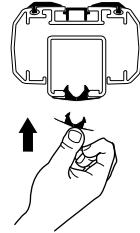
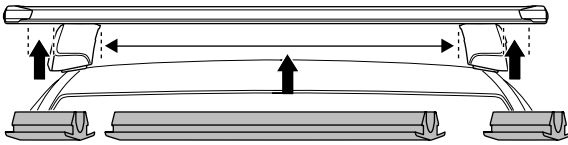
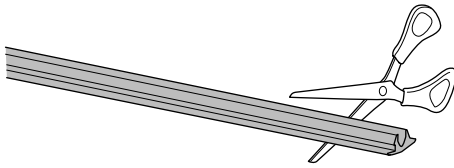

x2

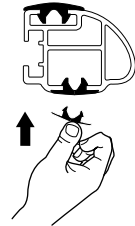
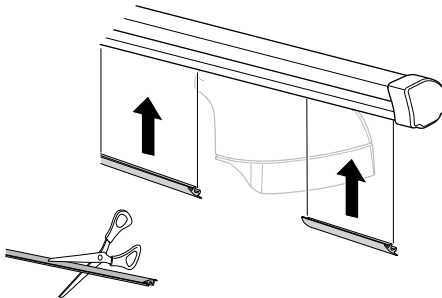
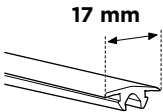

x2

i

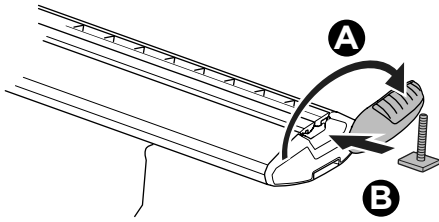

THULE
WingBar Evo

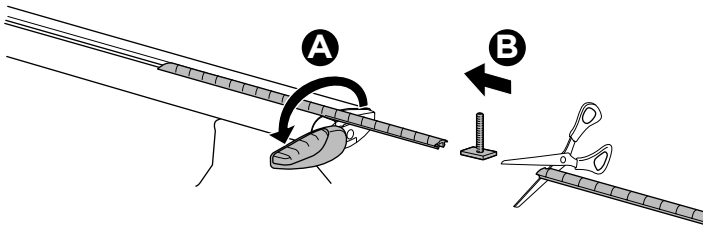
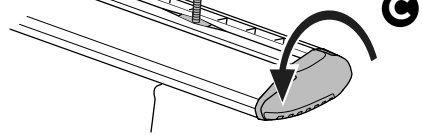

THULE
WingBar

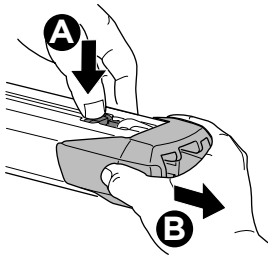

THULE
SlideBar

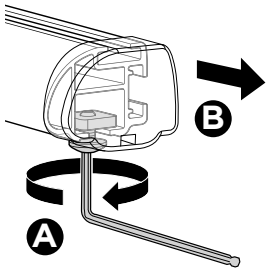
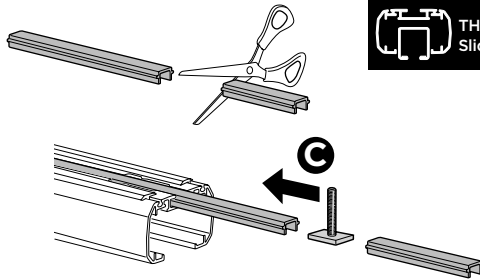

THULE
ProBar

